

Art.no 480-07, 480-08

FIRST USE

STEP 1.

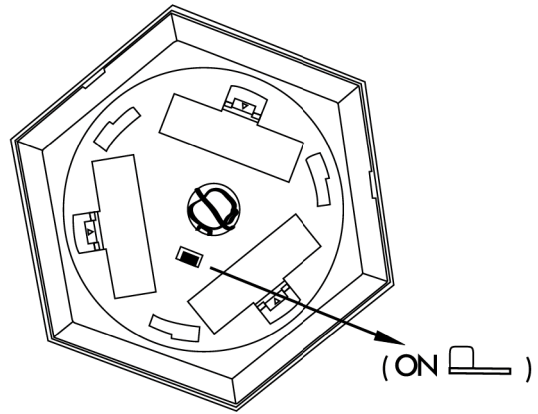

STEP 2.

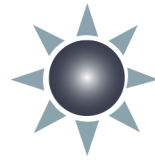

(ON )



(OFF )

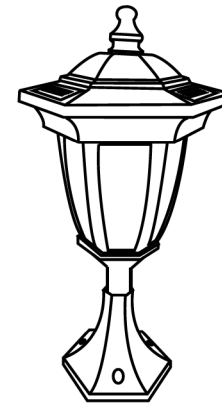

Ready after
36 h in the sun

BATTERY REPLACEMENT

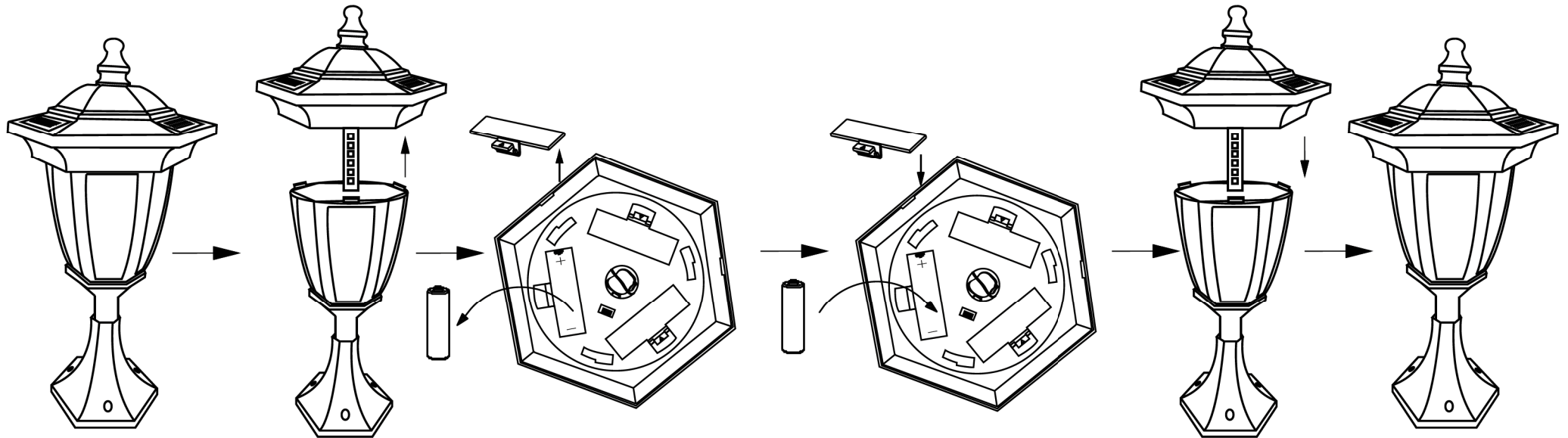

STAR[®]
TRADING

STAR STREET 1
512 50 SVENLJUNGA
SWEDEN

www.startrading.com