

Art.no 481-53
FIRST USE
STEP 1.

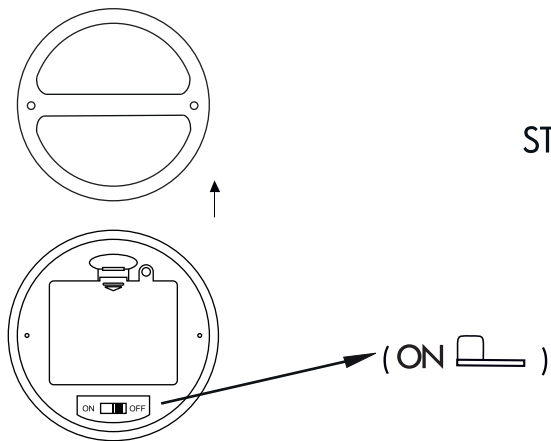

STEP 2.

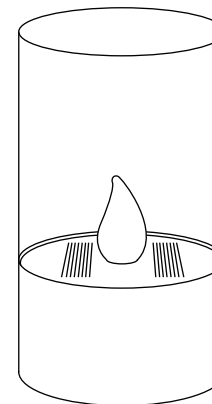
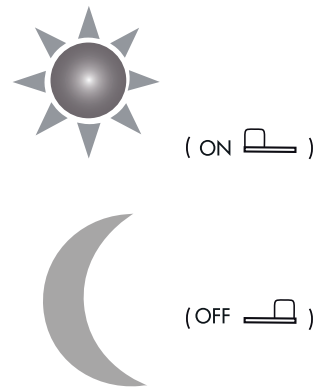

Ready after
36 h in the sun

BATTERY REPLACEMENT

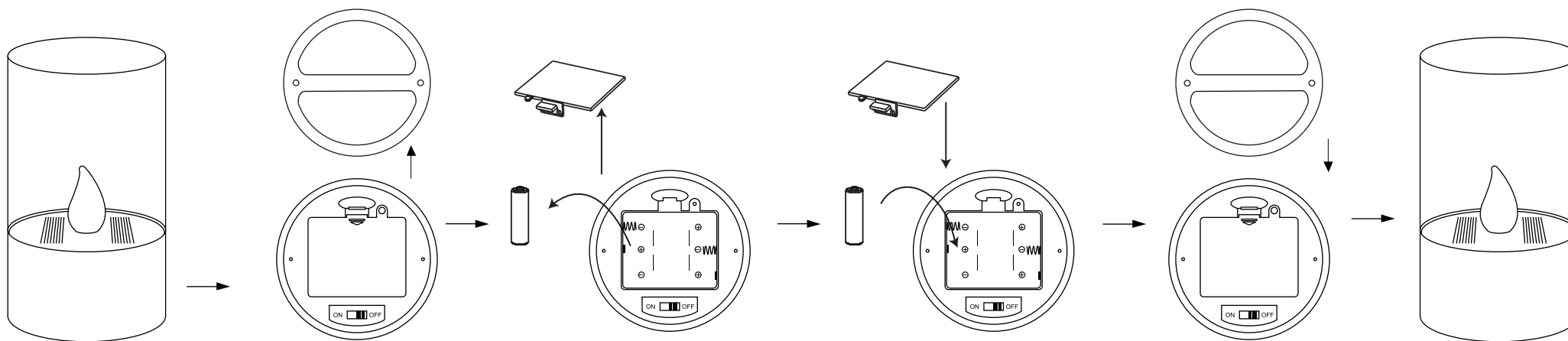

STAR[®]
TRADING
STAR STREET 1
512 50 SVENLJUNGA
SWEDEN
www.startrading.com