

Art.no 481-20

FIRST USE

STEP 1.

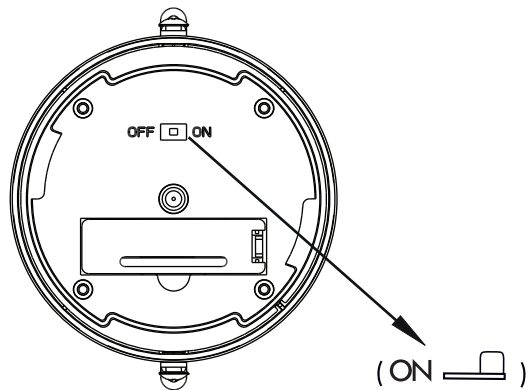

STEP 2.

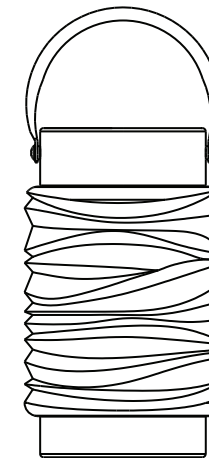
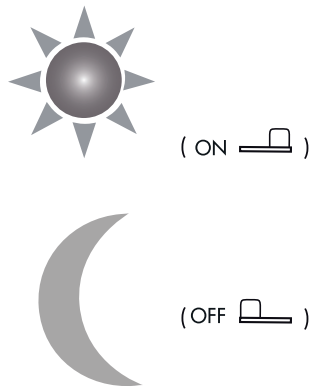

Ready after  
36 h in the sun

BATTERY REPLACEMENT

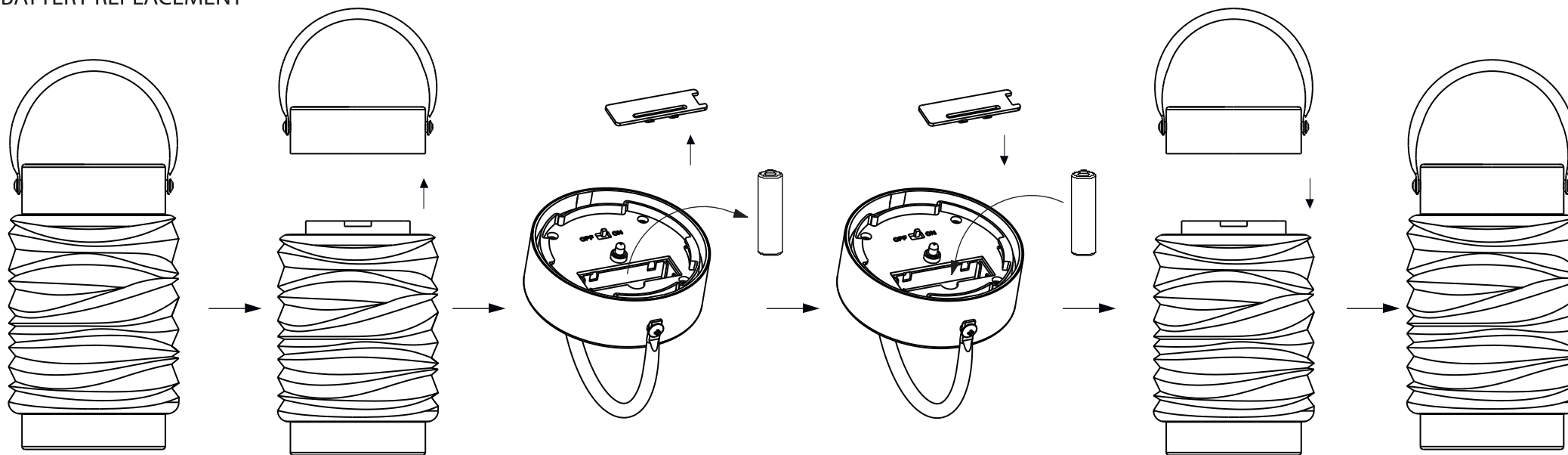

**STAR**<sup>®</sup>  
TRADING  
STAR STREET 1  
512 50 SVENLJUNGA  
SWEDEN  
[www.startrading.com](http://www.startrading.com)