

Art.no 481-28

FIRST USE

STEP 1.

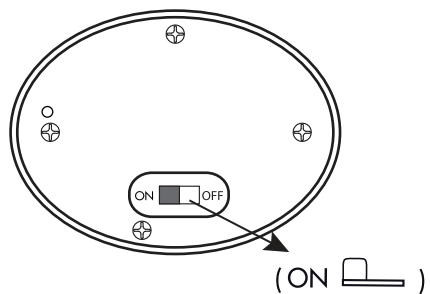

STEP 2.

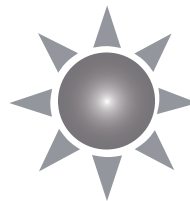

(ON [switch icon])



(OFF [switch icon])

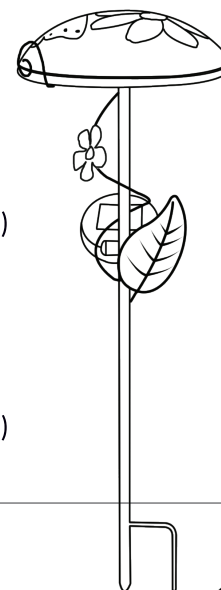

Ready after  
36 h in the sun

BATTERY REPLACEMENT

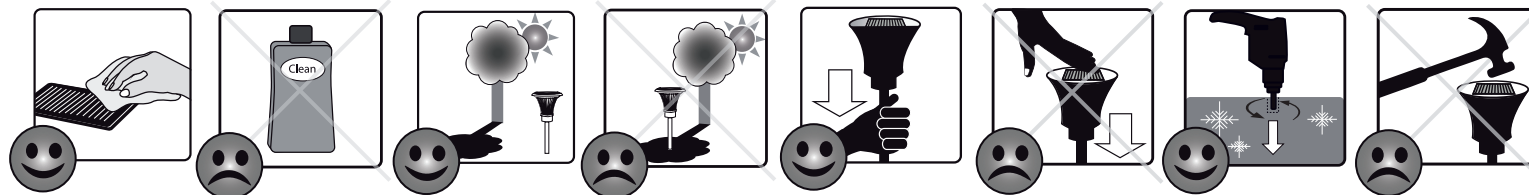
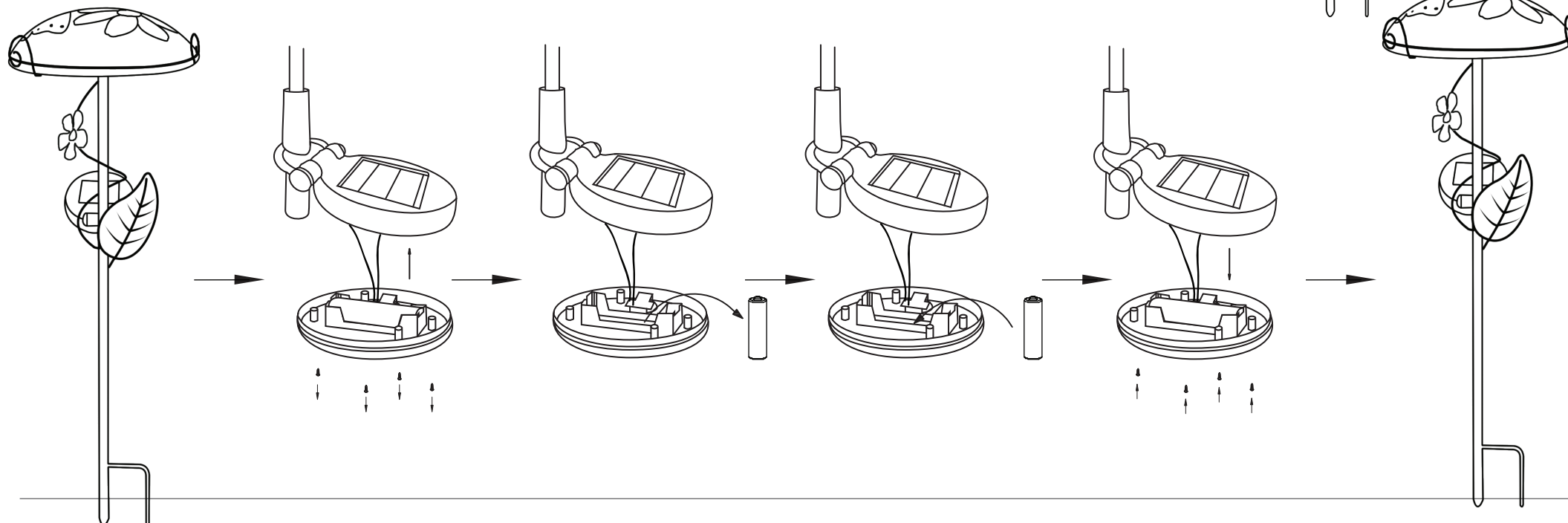

**STAR**<sup>®</sup>  
TRADING

STAR STREET 1  
512 50 SVENLJUNGA  
SWEDEN

[www.startrading.com](http://www.startrading.com)